

A
B
C
D
E
F

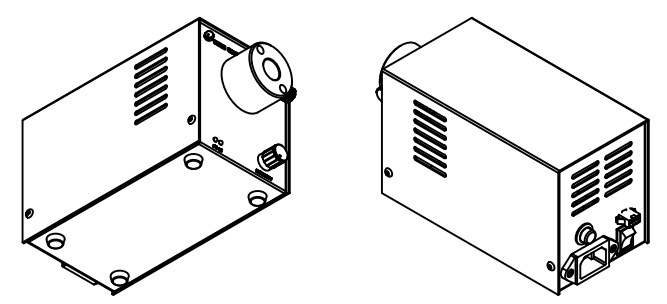
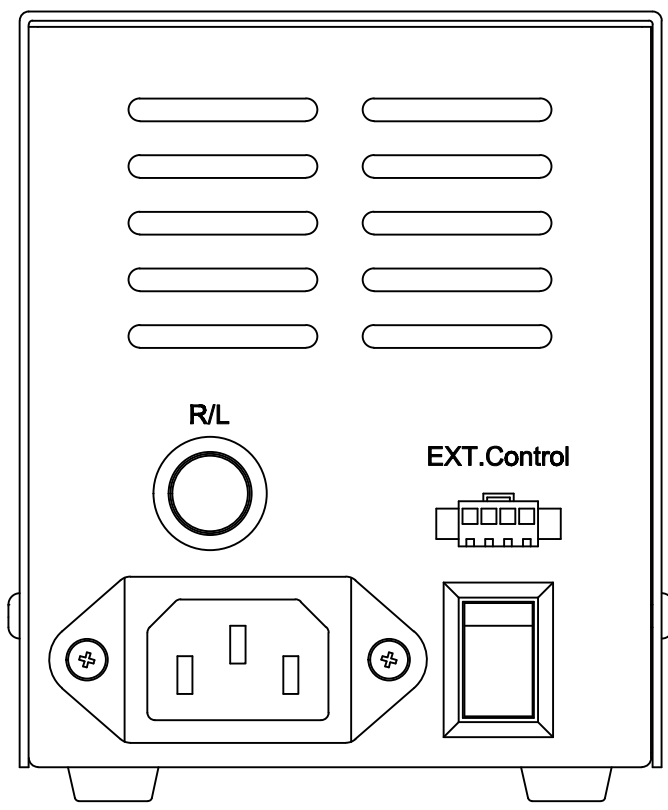
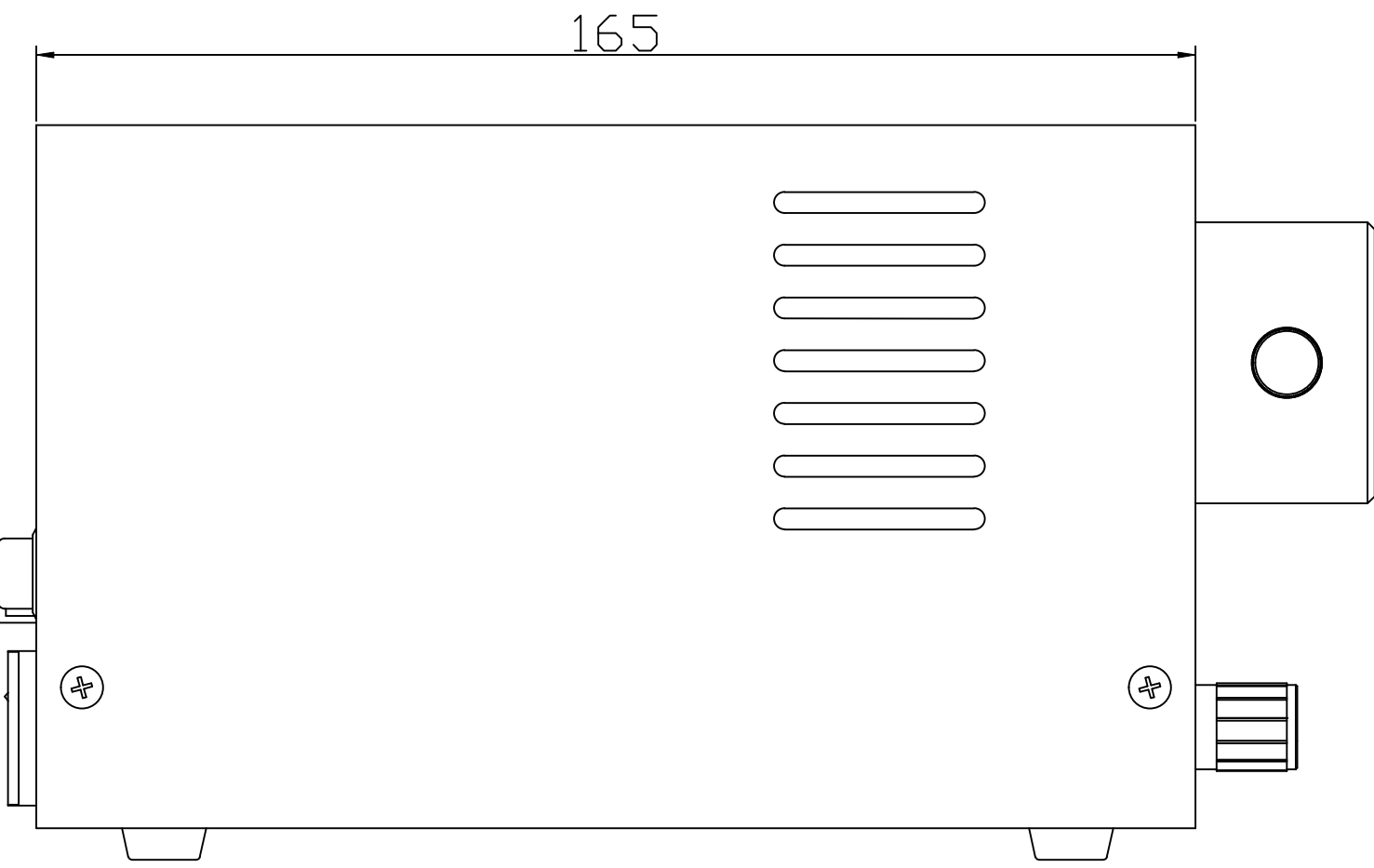
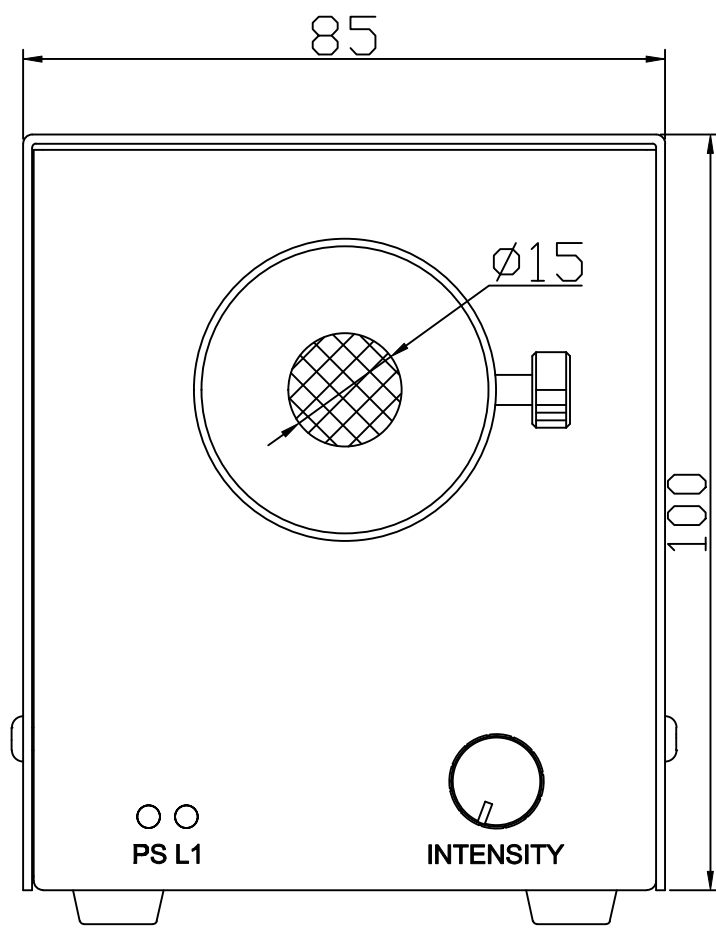

Itemref	Quantity	Material:			Article No./Reference	
Designed by DESIGNED_BY	Checked by CHECKED_BY	Approved by - date 2014-1-1	Filename WFB-15	Date 2014-1-1	Scale 1/1	
WAVECREST(SH)			WFB-15-USER			
			WFB-15-0000		Edition VER.1.0	Sheet 1