

A
B
C
D
E
F

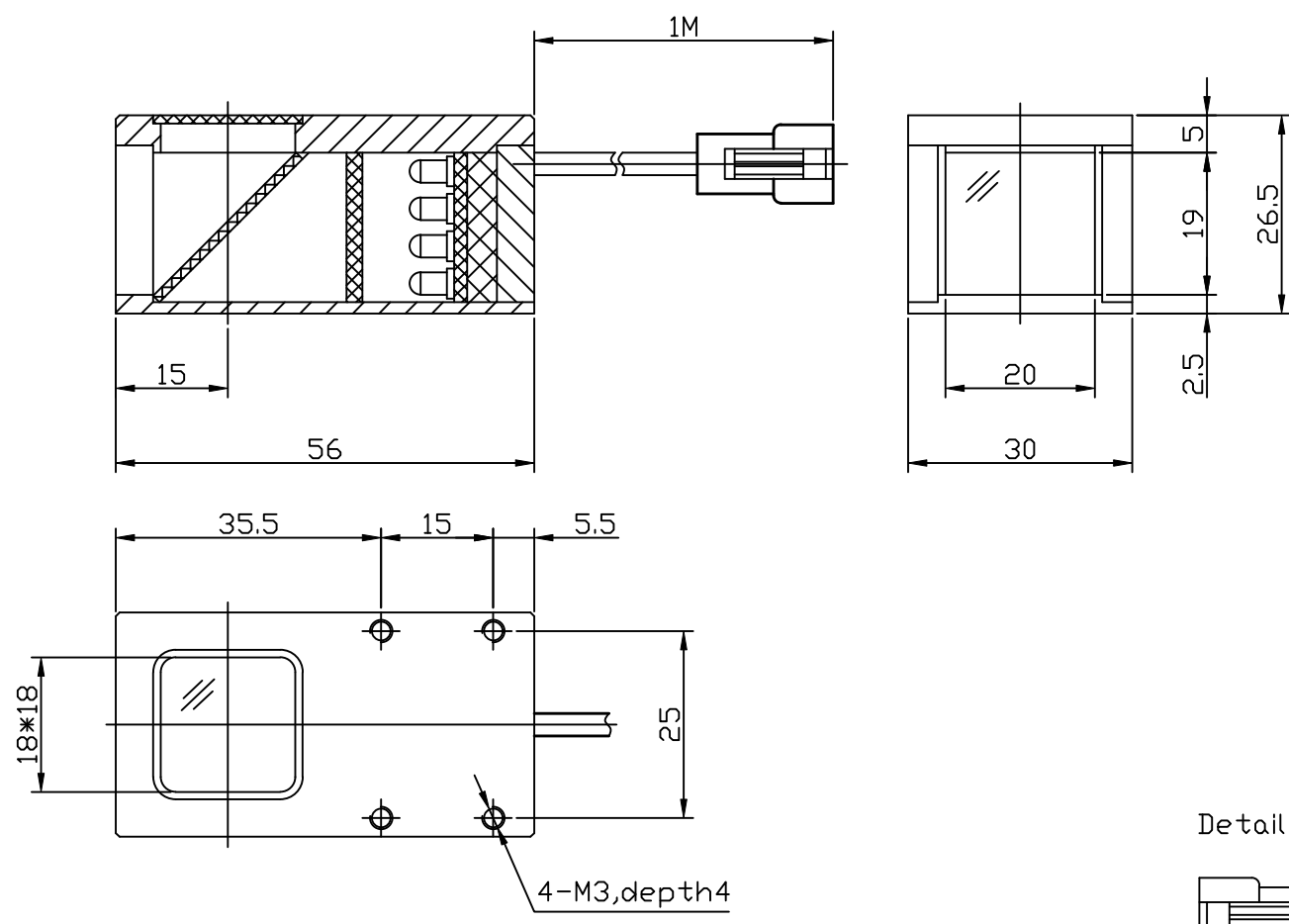

Details of Connector

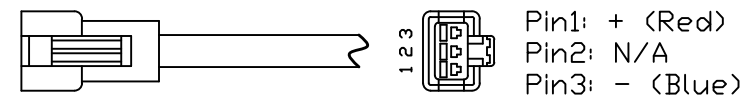

Connector Type: SMR-03V-B (Light Side)
SMP-03V-BC (Power Supply Side)

Specification:

MODEL	WLFVB-20-W/-B/-G/-UV	-Y/-R/-IR850/-IR940
Wavelength(nm)	6500K/470/525/390	590/625/850/940
Power Supply	DC24V/2.0(W)	DC24V/2.0(W)
Weight	80g	

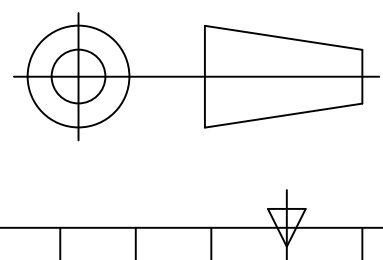

Itemref	Quantity	Material: AL	Article No./Reference		
Designed by DESIGNED_BY	Checked by CHECKED_BY	Approved by - date 2017-01-19	Filename WLFVB-20	Date 2017-01-19	Scale 1/1
WAVECREST(SH)			WLFVB-20-USER		
			WLFVB-20-0000	Edition VER.1.0	Sheet 1