

A
B
C
D
E
F

A
B
C
D
E
F

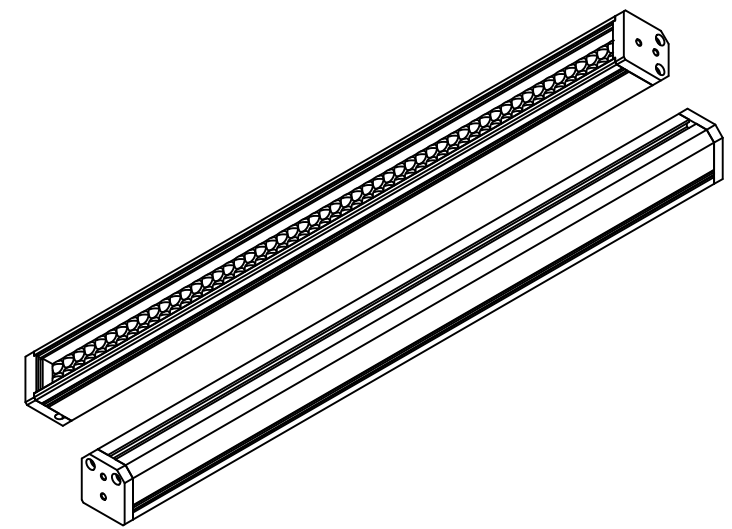

Details of Connector

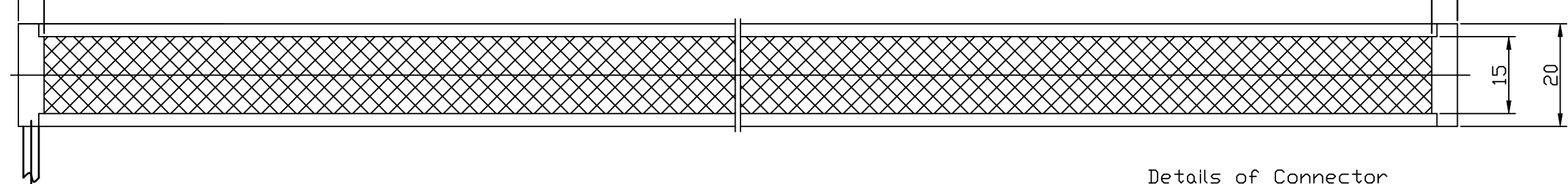
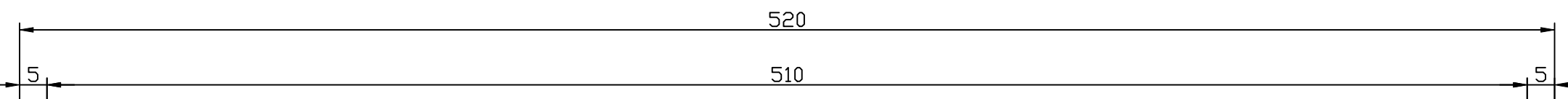
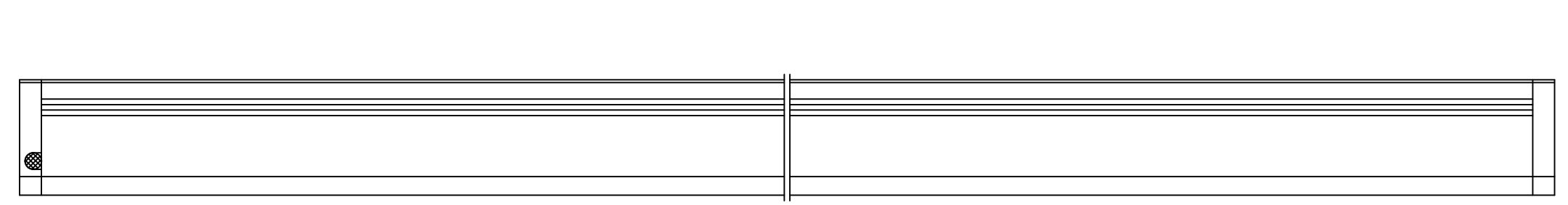
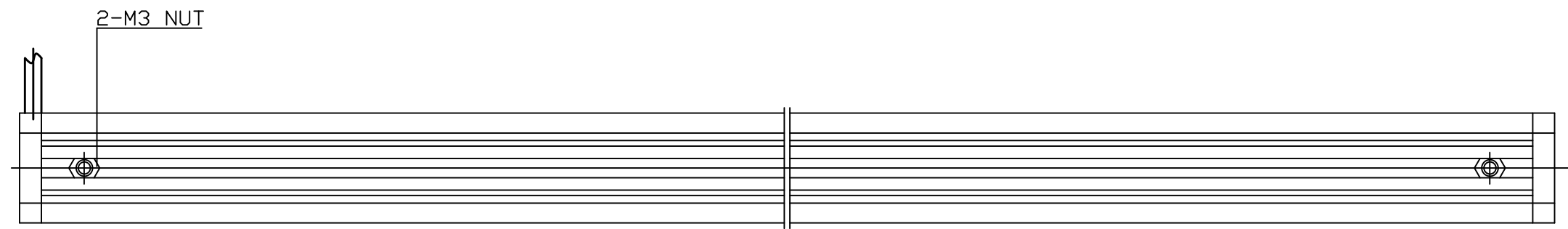
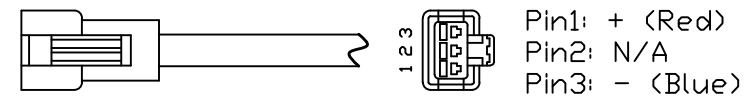

Connector Type: SMR-03V-B (Light Side)
SMP-03V-BC (Power Supply Side)

Specification:

| | | |
|----------------|-------------------------|---------------------|
| MODEL | WLDL-510L15-W/-B/-G/-UV | -Y/-R/-IR850/-IR940 |
| Wavelength(nm) | 6500K/470/525/390 | 590/625/850/940 |
| Power Supply | DC24V/24.5(W) | DC24V/16.3(W) |
| Weight | 280g | |

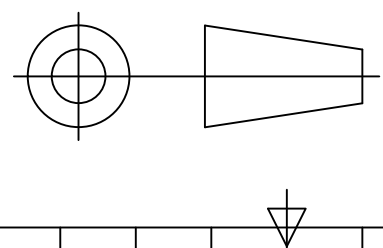

| | | | | | |
|-------------------------|---------------------|------------------------------------|-------------------------|----------------------|--------------|
| Itemref | Quantity | Material: AL | Article No./Reference | | |
| Designed by Y.KOTANI | Checked by T.ONO | Approved by - date JULY-20,2014 | Filename WLDL-510L15 | Date JULY-20,2014 | Scale 1/1 |
| WAVECREST(SH) | | | WLDL-510L15-USER | | |
| | | | WLDL-510L15-0000 | Edition VER.1.0 | Sheet 1 |