

**2/3inch Format**

**High resolution 2 Megapixel Lenses**

**Item No. GMHR1214MCN**

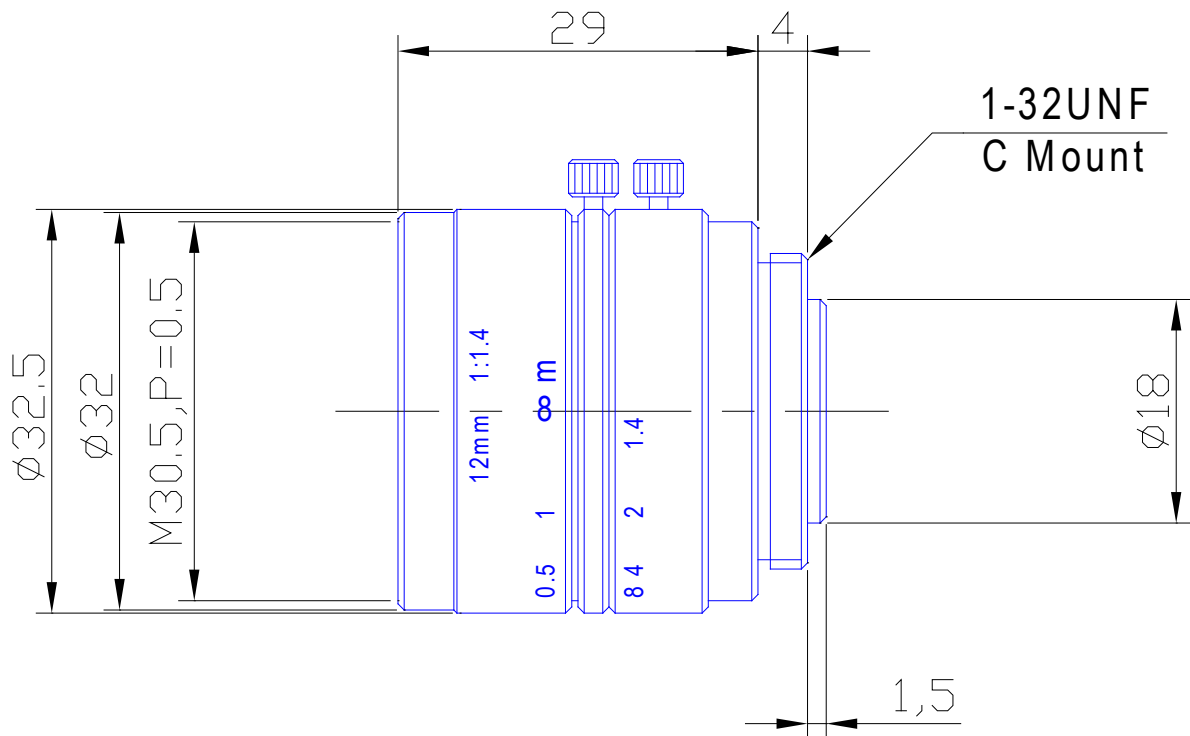

ITEM NO.	GMHR1214MCN	
Focal Length	12.0	(mm)
F No.	F1.4	
Angle of View(HxVxD)	39° x 30°	
Distortion	-0.08%(1/3"),-0.11%(1/2"),-0.12%(2/3")	
MOD	0.1	(m)
Filter Thread	M=30.5 , P=0.5	
Dimention ( D x L )	$\varnothing 32.5$ x 29	(mm)
Weight	61.5	(g)